

On the Dual Representation Model and Its Applications

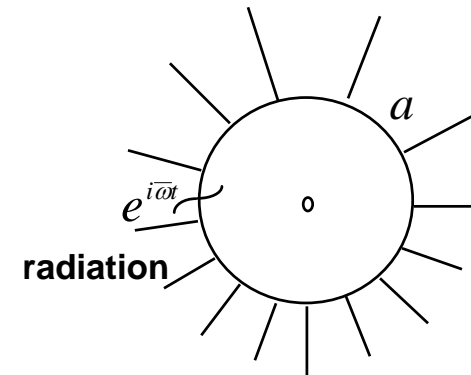
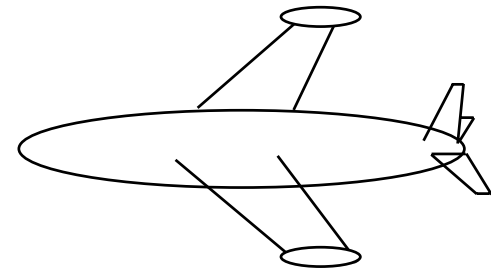
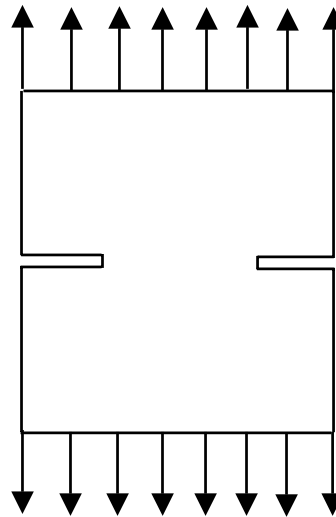
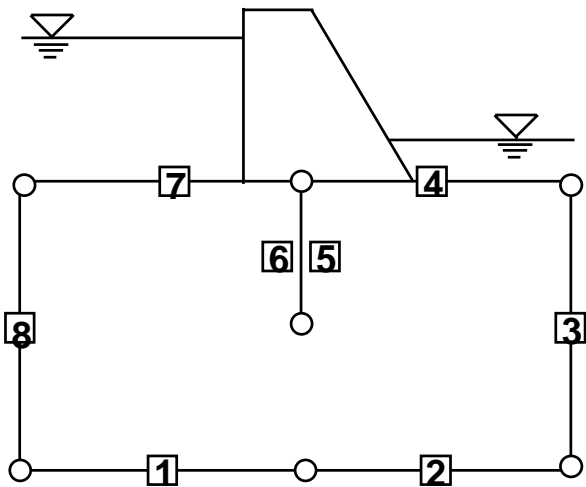

J.T. Chen

Department of Civil Engineerin, National Taiwan University

Presentation for Institute of Applied Mechanics, May 13, 1994



Outlines

- **Introduction to BEM**
- **Introduction to dual BEM**
- **Theory of dual integral equations**
- **Theory of dual series representations**
- **The roles of dual integral equations**
- **Regularization methods for hypersingularity**
- **Regularization methods for divergent series**
- **Applications of dual integral equations**
- **Applications of dual series representations**
- **Conclusions**

Growth Rate of BEM Papers

← Cauchy singularity → | hypersingularity | divergent series |

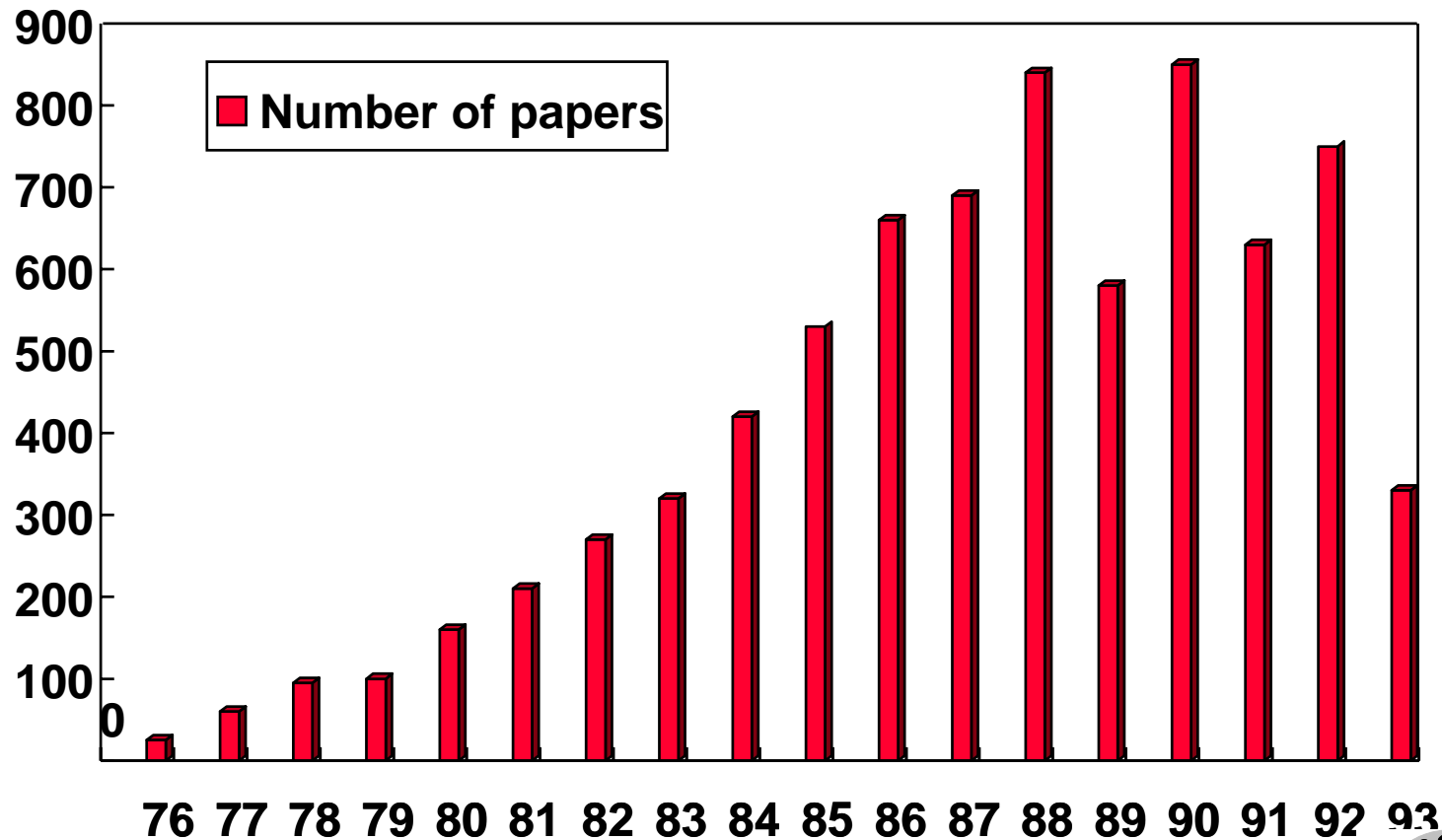

Dual Integral Equations by Hong and Chen(1984-1986)

Singular integral equation



Hypersingular integral equation

Cauchy principal value



Hadamard principal value

Boundary element method



Dual boundary element method

**normal
boundary**

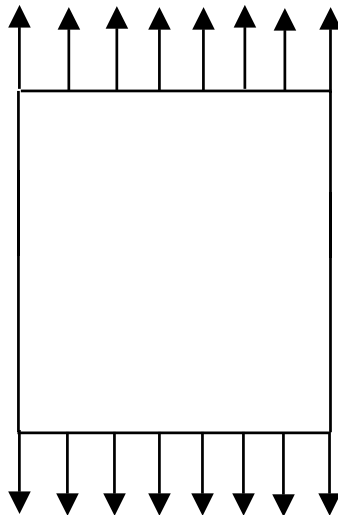

**degenerate
boundary**

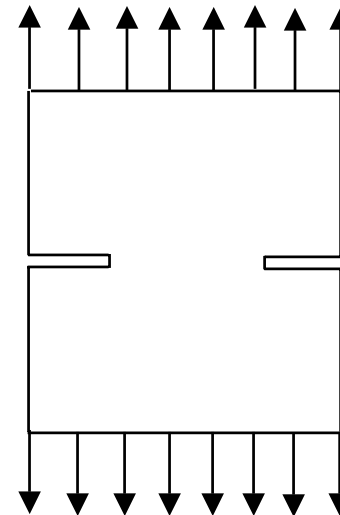

What Is Boundary Element Method ?

• Finite element method

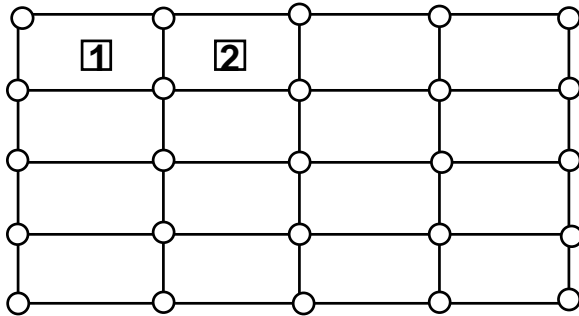

○ geometry node

Boundary element method

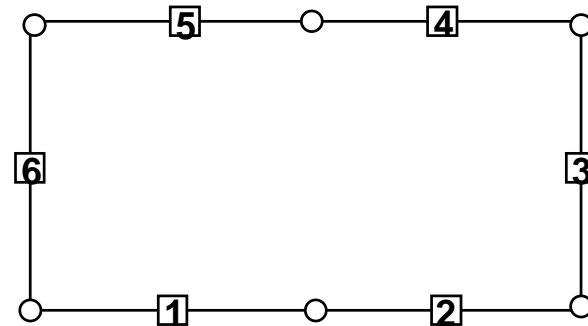

□ the Nth constant or linear element

What Is Dual Boundary Element Method ?

- **Boundary element method**

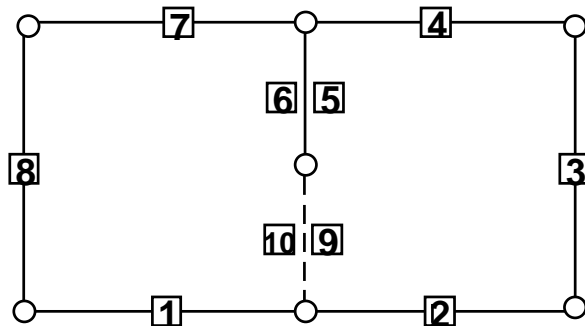

Artificial boundary introduced !

Dual boundary element method

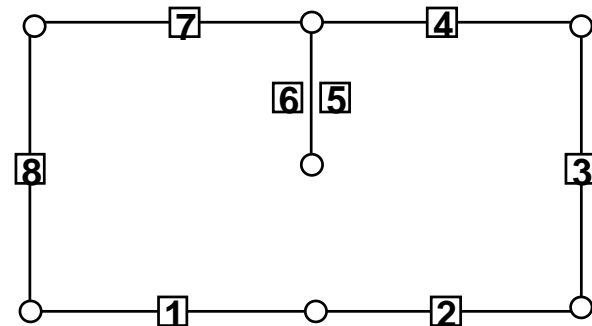

Dual integral equations needed !

Theory of Dual Integral Equations Dual Boundary Element Method

• Boundary element method

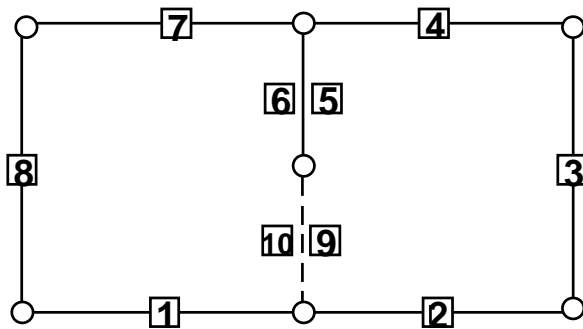

Only U, T equation is used

$$2\pi u(x) = \int_B T(s, x)u(s)dB(s) - \int_B U(s, x)t(s)dB(s), \quad x \in D$$

$$2\pi t(x) = \int_B M(s, x)u(s)dB(s) - \int_B L(s, x)t(s)dB(s), \quad x \in D$$

Dual boundary element method

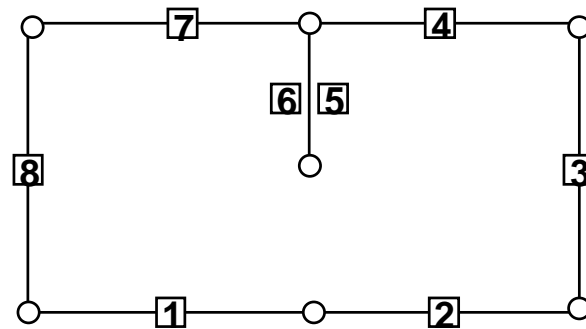

Both equations are used

Theory of Dual Integral Equations

- Dual integral equations for domain point

$$2\pi u(x) = \int_B T(s, x)u(s)dB(s) - \int_B U(s, x)t(s)dB(s), \quad x \in D$$

$$2\pi t(x) = \int_B M(s, x)u(s)dB(s) - \int_B L(s, x)t(s)dB(s), \quad x \in D$$

$u(s) = \text{specified}$

$t(s) = ?$

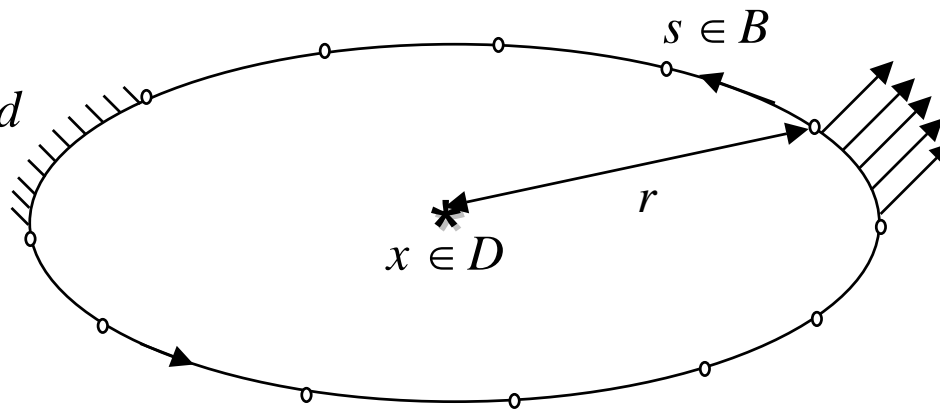

Theory of Dual Integral Equations

- Dual integral equations for boundary point

$$\pi u(x) = C.P.V. \int_B T(s, x) u(s) dB(s) - R.P.V. \int_B U(s, x) t(s) dB(s), \quad x \in B$$

$$\pi t(x) = H.P.V. \int_B M(s, x) u(s) dB(s) - C.P.V. \int_B L(s, x) t(s) dB(s), \quad x \in B$$

$u(s) = \text{specified}$

$t(s) = ?$

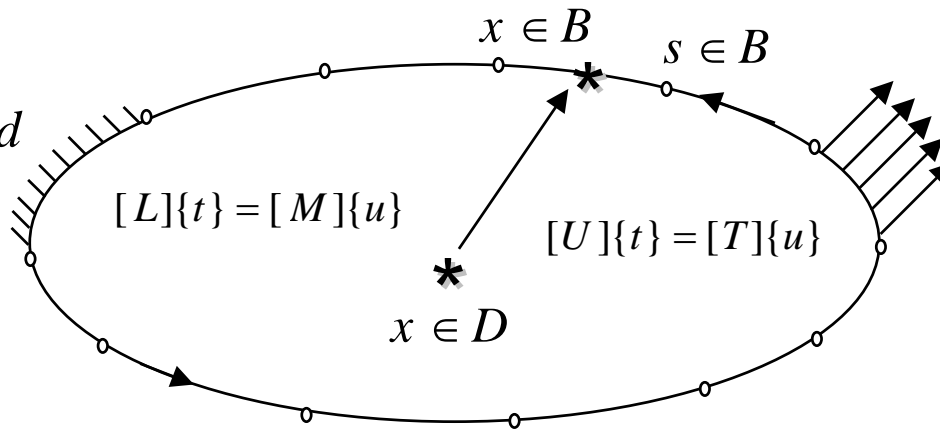

$t(s) = \text{specified}$

$u(s) = ?$

Degeneracy of the Degenerate Boundary

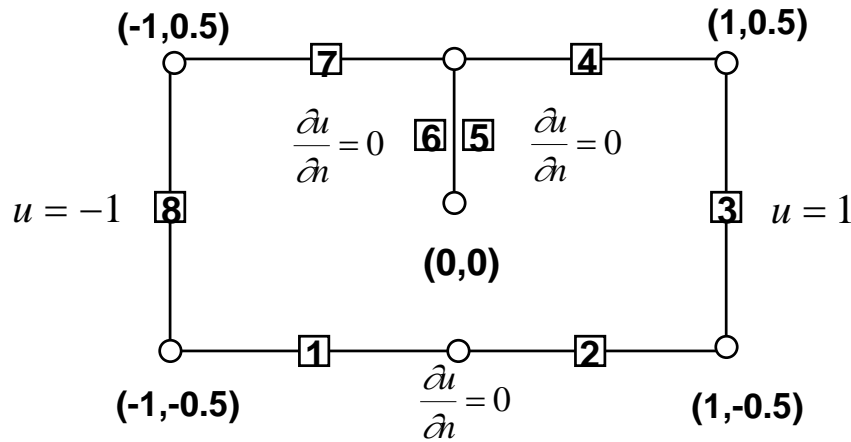

- geometry node
- ◻ the Nth constant or linear element

$$[U]\{t\} = [T]\{u\}$$

$$[L]\{t\} = [M]\{u\}$$

	5(+)								6(+)							
[U]	1.693	-0.045	0.471	0.347	-0.054	-0.054	0.039	-0.335	-0.045	-1.693	-0.335	0.039	-0.054	-0.054	0.347	0.471
	-0.045	-1.693	-0.335	0.039	-0.054	-0.054	0.347	0.471	0.445	-0.335	-1.693	-0.335	0.019	0.019	0.445	0.703
	0.445	-0.335	-1.693	-0.335	0.019	0.019	0.445	0.703	0.347	0.039	-0.335	-1.693	-0.281	-0.281	-0.045	0.471
	0.347	0.039	-0.335	-1.693	-0.281	-0.281	-0.045	0.471	-0.081	-0.081	0.063	-0.638	-1.193	-1.193	-0.638	0.063
	-0.081	-0.081	0.063	-0.638	-1.193	-1.193	-0.638	0.063	-0.081	-0.081	0.063	-0.638	-1.193	-1.193	-0.638	0.063
	-0.081	-0.081	0.063	-0.638	-1.193	-1.193	-0.638	0.063	0.039	0.347	0.471	-0.045	-0.281	-0.281	-1.693	-0.334
	0.039	0.347	0.471	-0.045	-0.281	-0.281	-1.693	-0.334	-0.335	0.445	0.703	0.445	0.019	0.019	-0.335	-1.693
	-0.335	0.445	0.703	0.445	0.019	0.019	-0.335	-1.693								

	n(s)								5(+)								6(-)							
[T]	-π	0.000	0.588	0.519	-0.321	0.321	0.927	1.107	0.000	-π	1.107	0.927	0.321	-0.321	0.519	0.588								
	0.000	-π	1.107	0.927	0.321	-0.321	0.519	0.588	0.219	1.107	-π	1.107	0.464	-0.464	0.219	0.490								
	0.219	1.107	-π	1.107	0.464	-0.464	0.219	0.490	0.519	0.927	1.107	-π	0.785	-0.785	0.000	0.588								
	0.519	0.927	1.107	-π	0.785	-0.785	0.000	0.588	0.927	0.927	0.888	1.326	-π	-π	1.326	0.888								
	0.927	0.927	0.888	1.326	-π	-π	1.326	0.888	0.927	0.927	0.888	1.326	-π	-π	1.326	0.888								
	0.927	0.927	0.888	1.326	-π	-π	1.326	0.888	0.927	0.519	0.588	0.000	-0.7854	0.785	-π	1.107								
	0.927	0.519	0.588	0.000	-0.7854	0.785	-π	1.107	1.107	0.219	0.490	0.219	-0.464	0.464	1.107	-π								

	5(+)								6(+)							
n(x)	π	0.000	0.184	0.519	0.458	0.458	0.927	0.805	0.000	π	0.805	0.927	0.458	0.458	0.519	0.184
	0.000	π	0.805	0.927	0.458	0.458	0.519	0.184	0.612	0.805	π	0.805	0.464	0.464	0.612	0.490
	0.612	0.805	π	0.805	0.464	0.464	0.612	0.490	0.519	0.927	0.805	π	0.347	0.347	0.000	0.184
	0.519	0.927	0.805	π	0.347	0.347	0.000	0.184	0.511	0.511	0.888	1.417	π	-π	-1.417	-0.888
	0.511	0.511	0.888	1.417	π	-π	-1.417	-0.888	0.511	-0.511	-0.888	-1.417	-π	π	1.417	0.888
	0.511	-0.511	-0.888	-1.417	-π	π	1.417	0.888	0.927	0.519	0.184	0.000	0.347	0.347	π	0.805
	0.927	0.519	0.184	0.000	0.347	0.347	π	0.805	0.805	0.612	0.490	0.612	0.464	0.464	0.805	π
	0.805	0.612	0.490	0.612	0.464	0.464	0.805	π								

	n(s)								5(+)								6(-)							
n(x)	4.000	-1.333	-0.205	-0.061	0.600	-0.600	-0.800	-1.600	4.000	-1.333	-0.205	-0.061	0.600	-0.600	-0.800	-1.600								
	-1.333	4.000	-1.600	-0.800	-0.600	0.600	-0.061	-0.205	0.282	-1.600	4.000	-1.600	-0.400	0.400	-0.282	-0.236								
	0.282	-1.600	4.000	-1.600	-0.400	0.400	-0.282	-0.236	-0.061	-0.800	-1.600	4.000	-1.000	1.000	-1.333	-0.205								
	-0.061	-0.800	-1.600	4.000	-1.000	1.000	-1.333	-0.205	0.853	-0.853	-0.715	-3.765	8.000	-8.000	3.765	0.715								
	0.853	-0.853	-0.715	-3.765	8.000	-8.000	3.765	0.715	-0.853	0.853	0.715	3.765	-8.000	8.000	-3.765	-0.715								
	-0.853	0.853	0.715	3.765	-8.000	8.000	-3.765	-0.715	-0.800	-0.062	-0.205	-1.333	1.000	-1.000	4.000	-1.600								
	-0.800	-0.062	-0.205	-1.333	1.000	-1.000	4.000	-1.600	-1.600	-0.282	-0.235	-0.282	0.400	-0.400	-1.600	4.000								

Definitions of R.P.V., C.P.V. and H.P.V.

- **R.P.V.**

$$R.P.V. \int_{-1}^1 \ln|x| dx = (x \ln|x| - x) \Big|_{x=-1}^{x=1} = -2$$

- **C.P.V.**

$$C.P.V. \int_{-1}^1 \frac{1}{x} dx = \lim_{\varepsilon \rightarrow 0} \int_{-1}^{-\varepsilon} \frac{1}{x} dx + \int_{\varepsilon}^1 \frac{1}{x} dx = 0$$

- **H.P.V.**

$$H.P.V. \int_{-1}^1 \frac{1}{x^2} dx = \lim_{\varepsilon \rightarrow 0} \int_{-1}^{-\varepsilon} \frac{1}{x^2} dx + \int_{\varepsilon}^1 \frac{1}{x^2} dx - \frac{2}{\varepsilon} = -2$$

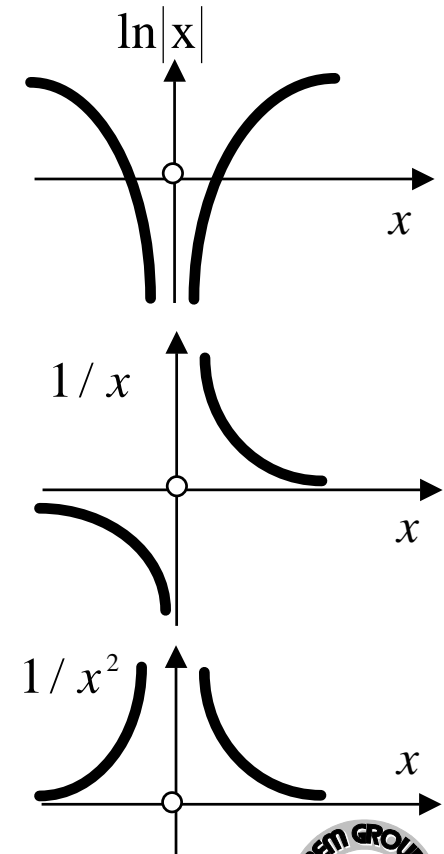

Regularization methods for hypersingularity

use of simple solutions

1. constant potential
2. rigid body motion
3. complementary solution
 - (a). nondegenerate boundary
 - (b). degenerate boundary: enclosing technique

kernel function

1. static kernel subtraction
2. quasi-static part decomposition
3. integration by parts reduction one order singularity for kernel

density function

1. regularized u
 $u(s) \rightarrow u(s) - u(x)$
2. regularized u, t
 $u(s) \rightarrow u(s) - u(x) - u'(x)r_i\bar{s}_i - t(x)r_i\bar{n}_i$
 $t(s) \rightarrow t(s) - t(x)$
3. integration by parts
 $u(s) \rightarrow u'(s)$

trace to boundary

1. limiting process
2. jump function
3. L'Hospital rule
4. Cesaro sum

surrounding integral

1. CPV concept
2. HPV concept
3. free term
4. Introducing boundary terms
 - (a). Stokes' theorem
 - (b). integration by parts
 - (c). Stokes' transformation
 - (d). summation by parts
 - (e). Leibnitz rule
5. quadrature rule

Applications of Dual Integral Equations

Crack problem

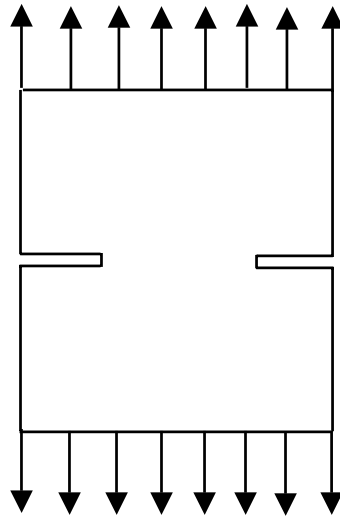

Work in CSIST (1986-1990)

Analysis, Design and Experiment for Solid Rocket Motor



Research in CSIST (1986-1990)

Solid mechanics



Aerodynamics

Hadamard principal value



Mangler principal value

Boundary element method



Panel method

Crack problem

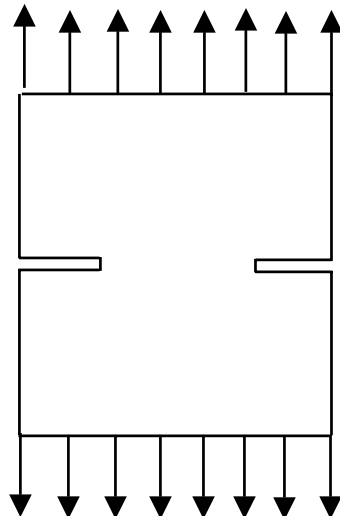

Thin-airfoil Aerodynamics

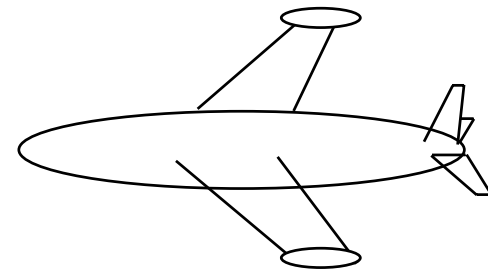

Two Books in CSIST (1986-1990)

Book for academic research

BEM

Book for industry applications

FEM

with MSC/NASTRAN



Research in NTUCE (1990-present)

Crack problem

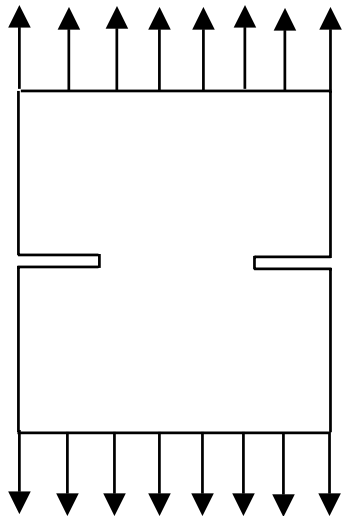

Seepage with sheetpiles

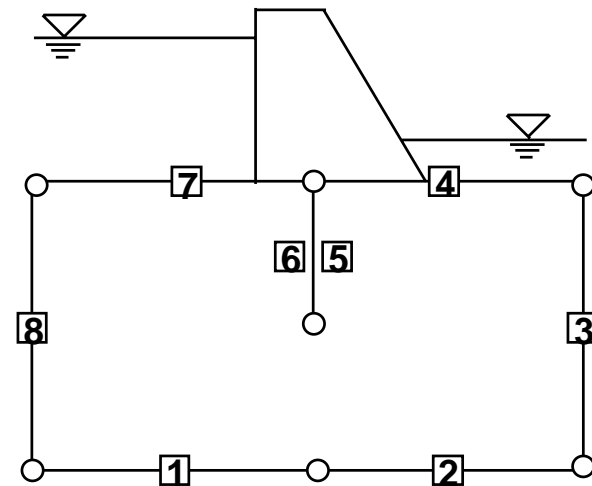

Roles of hypersingularity in boundary element method

complementary constraints

higher order element

degenerate boundary

corner problem

fictitious eigenvalue

adaptive BEM

secondary field calculation

condition number

symmetry formulation

image system

1. Hermite element

1. cutoff wall
2. sheet pile
3. crack
4. baffle
5. thin airfoil
6. antenna

$$\begin{matrix} (o) \\ (o) \\ (x) \end{matrix} \begin{cases} [U]\{t\} = [T]\{u\} \\ [L]\{t\} = [M^{-}]\{u\} \\ [L]\{t\} = [M^{-}]\{u\} \\ [L]\{t\} = [M^{-}]\{u\} \end{cases}$$

$$\begin{matrix} 1. \\ 2. \\ 3. \end{matrix} \begin{cases} [U]\{t\} = [T]\{u\} \\ [L]\{t\} = [M^{-}]\{u\} \\ [L]\{t\} = [M^{-}]\{u\} \\ [L]\{t\} = [M^{-}]\{u\} \end{cases}$$

1. kernel function
2. region of singularity
3. boundary condition

1. error estimator

1. hoop stress on boundary
2. tangent flux along boundary
3. regularized version for stress near boundary

1. pseudo-differential operator

$U(-1)$	$T(0)$
$L(0)$	$M(1)$
2. T, L is more stable than U, M

1. double boundary integration

1. normal vector of dipole or dislocation

Growth Rate of BEM Papers

← Cauchy singularity → | hypersingularity | divergent series |

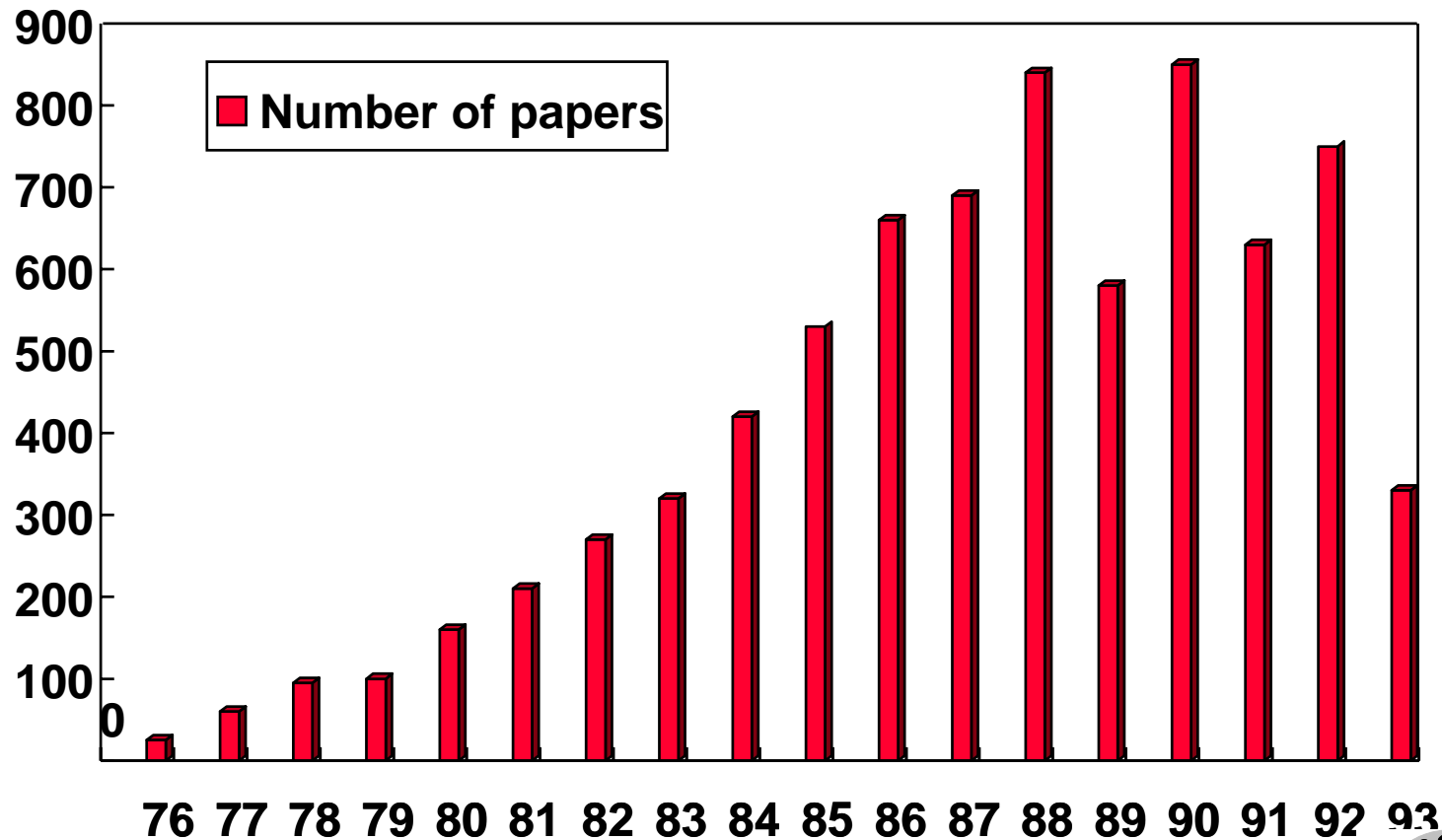

Why Dual Series Representations ? Support Motion Problems

$$\rho \frac{\partial^2 u(x,t)}{\partial t^2} + (2\alpha\rho - \beta G) \frac{\partial u(x,t)}{\partial x^2} - G \frac{\partial^2 u(x,t)}{\partial x^2} = 0$$

dynamic
response ?



random
response ?

History of The Research on Divergent Series

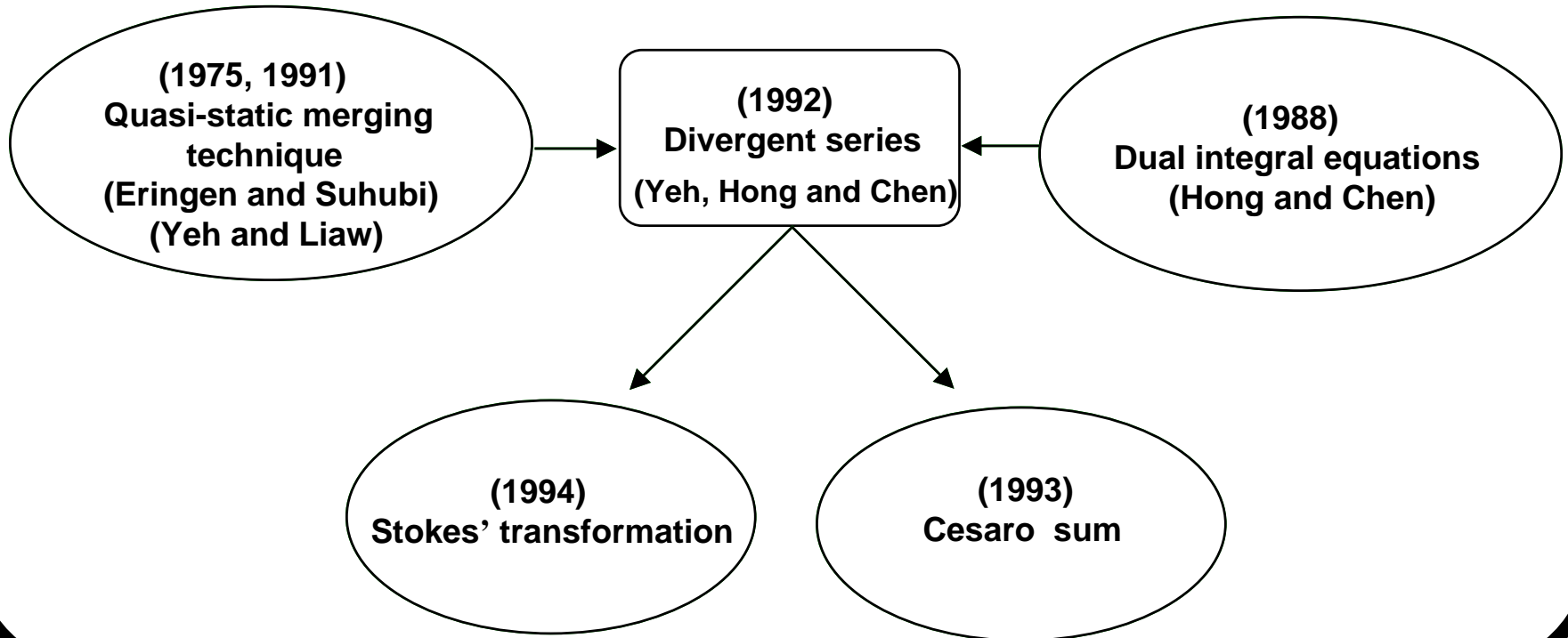

Methods of Solution

- **Quasi-static decomposition method (Mindlin and Goodman, 1950)**
Accelerate the convergence rate
- **Series representation (Eringen and Suhubi, 1975, Yeh and Liaw, 1991)**
Quasi-static solution is not necessary to be determined
- **Low convergence and divergence will occur using series representation proposed by Pilkey**

- **Two goals**
Omit the calculation of quasi-static solution
Accelerate the convergence rate

Dual Integral Equations and Dual Series Representation

- Dual Integral Equations:**

$$\begin{aligned}
 u(x,t) &= \int_0^t \int_B U(s,x;\tau,t) \mathfrak{F}(s,\tau) dB(s) d\tau - \int_0^t \int_B T(s,x;\tau,t) \mathfrak{G}(s,\tau) dB(s) d\tau \\
 &\quad + \int_0^t \int_V U(s,x;\tau,t) f(s,\tau) dV(s) d\tau \\
 t(x,t) &= \int_0^t \int_B L(s,x;\tau,t) \mathfrak{F}(s,\tau) dB(s) d\tau - \int_0^t \int_B M(s,x;\tau,t) \mathfrak{G}(s,\tau) dB(s) d\tau \\
 &\quad + \int_0^t \int_V L(s,x;\tau,t) f(s,\tau) dV(s) d\tau
 \end{aligned}$$

- Series :**

$$\begin{aligned}
 U(s,x;\tau,t) &= \lim_{N \rightarrow \infty} C(N,1) \left\{ \sum_{m=1}^N e^{-k\omega_m(t-\tau)} u_m(x) u_m(s) / N_m \right\} \\
 T(s,x;\tau,t) &= \lim_{N \rightarrow \infty} C(N,1) \left\{ \sum_{m=1}^N e^{-k\omega_m(t-\tau)} u_m(x) t_m(s) / N_m \right\} \\
 L(s,x;\tau,t) &= \lim_{N \rightarrow \infty} C(N,2) \left\{ \sum_{m=1}^N e^{-k\omega_m(t-\tau)} t_m(x) u_m(s) / N_m \right\} \\
 M(s,x;\tau,t) &= \lim_{N \rightarrow \infty} C(N,2) \left\{ \sum_{m=1}^N e^{-k\omega_m(t-\tau)} t_m(x) t_m(s) / N_m \right\}
 \end{aligned}$$

$C(N,r)$: Cesaro operator with order r



Cesaro Regularization Technique

- **Series Solution(Partial Sum)**

$$s_0 = a_0$$

$$s_1 = a_0 + a_1$$

$$s_2 = a_0 + a_1 + a_2$$

⋮

$$s_{N-1} = a_0 + a_1 + a_2 + \dots + a_{N-1}$$

(partial sum) $s_N = a_0 + a_1 + a_2 + \dots + a_{N-1} + a_N$ (divergent, $N \rightarrow \infty$)

$$\frac{s_0 + s_1 + \dots + s_{N-1} + s_N}{N+1} = a_0 + \frac{N}{N+1}a_1 + \frac{N-1}{N+1}a_2 + \dots + \frac{2}{N+1}a_{N-1} + \frac{1}{N+1}a_N \quad (\text{convergent, } N \rightarrow \infty)$$

(Cesaro sum) $S_N = \frac{1}{N+1} \sum_{k=0}^N (N-k+1) a_k$ (moving average)

Stokes' Transformation --- Summation by Parts

- **Term by Term Differentiation Is Not Always Legal**
- **Boundary Term Is Present for Some Cases**

$$f'(x) = \frac{d}{dx} \left[\sum_{k=0}^N c_k u_k(x) \right] = \sum_{k=0}^N c_k u_k'(x) + \sum_{k=0}^N b_k u_k'(x)$$

if $\sum_{k=0}^N b_k u_k'(x) \neq 0$

Boundary term

- **Term by Term Differentiation Is Legal**

if $\sum_{k=0}^N b_k u_k'(x) = 0$

Regularization Techniques for Derivative of Double Layer Potential Different Points of View

- **Divergent Integral (Hypersingular kernel) :**

$$H.P.V. \int M(s, x) u(s) dB(s)$$

- **Divergent Series (Dual series representation) :**

$$C(N, 2) \left\{ \sum_{m=0}^N \int_B t_n(s) u(s, t) dB(s) t_n(x) \right\}$$

- **Cesaro Sum (Arithmetic mean) :**

$$S_N(x, t) = C(N, 1) \left\{ \sum_{m=0}^N a_m(x, t) \right\} = \frac{s_0(x, t) + s_1(x, t) + \dots + s_{N-1}(x, t) + s_N(x, t)}{N + 1}$$

- **Reproducing Kernel (Fejer kernel) :**

$$F_{N+1}(x) = \frac{1}{2\pi(N+1)} \frac{\sin^2((N+1)x/2)}{\sin^2(x/2)}$$

- **Moving Average (MA model) :**

$$S_N(x, t) = \frac{1}{N+1} \sum_{m=0}^N (N-m+1) a_m(x, t)$$

- **Stokes' Transformation (Summation by parts) :**

$$f'(x) = \frac{d}{dx} \left[f(x) \right] = \frac{d}{dx} \left[\sum_{k=0}^N c_k u_k(x) \right] = \sum_{k=0}^N c_k u'_k(x) + \sum_{k=0}^N b_k u'_k(x)$$

Applications of Dual Series Representations

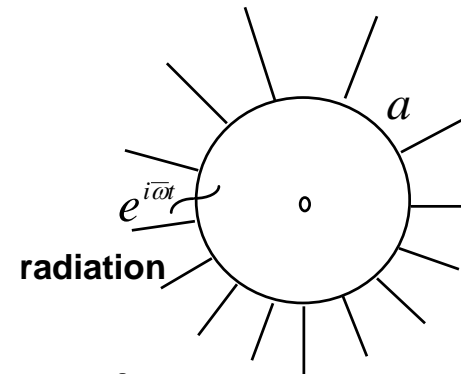

$$u = \lim_{\bar{\omega} \rightarrow \omega} \frac{0}{0} \rightarrow \text{finite}, \text{ if } \bar{\omega} \rightarrow \omega$$

Comparisons of CPU Time

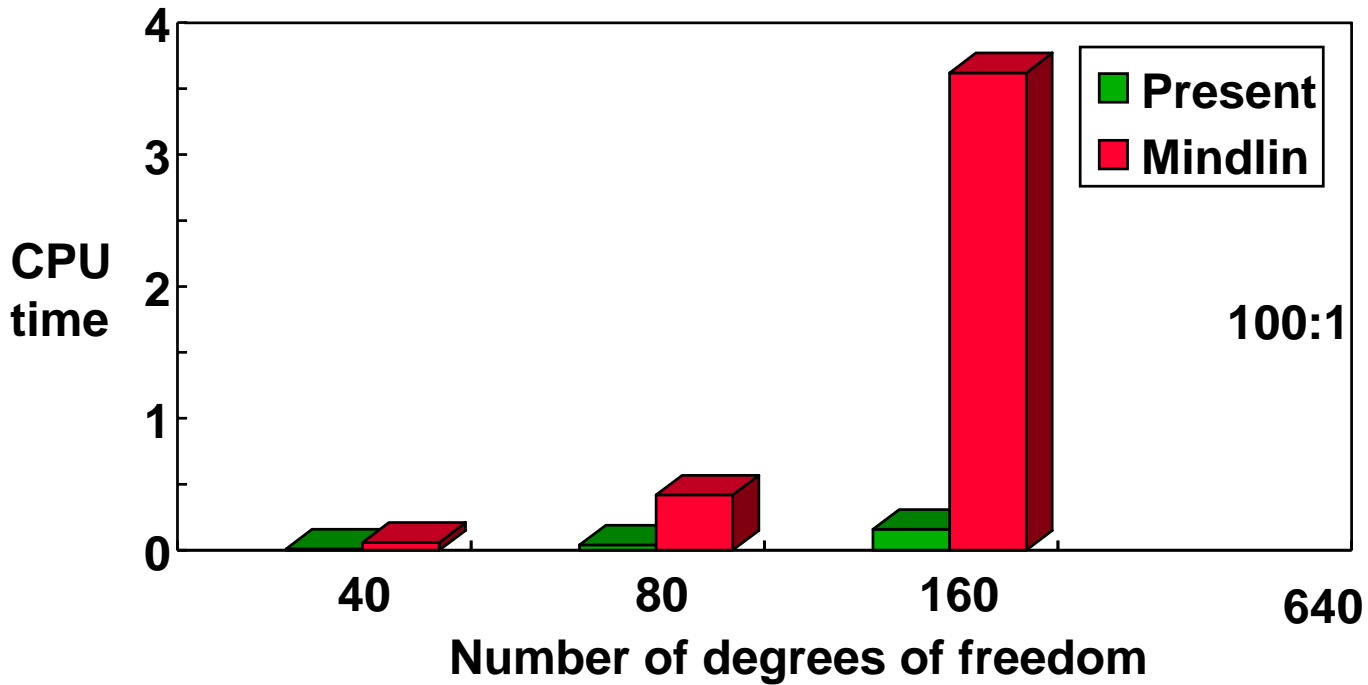

Reproducing Techniques for Solutions

Solution $u(x,t)$?

Modal dynamics

$$u(x,t) = \sum_{k=0}^{k=n} \bar{q}_k(t) u_k(x)$$

?

Fourier integral

$$u(x,t) = \int_{-\infty}^{\infty} U(x,\omega) e^{-i\omega t} d\omega$$

Reproducing

$$u(x,t) = C(N,r) \sum_{k=0}^{k=N} \bar{q}_k(t) u_k(x)$$

$$u(x,t) = \int_{-\pi}^{\pi} K_N^r(x-s) u(s,t) ds$$

$$K_N^1(x-s) = \frac{1}{(N+1)} \frac{\sin^2((N+1)(x-s)/2)}{\sin^2((x-s)/2)}$$

$$u(x,t) = \int_{-\infty}^{\infty} U(x,\omega) W(\omega) e^{-i\omega t} d\omega$$

$$u(x,t) = \sum_{k=-N}^{k=N} U(x,\omega_k) w_k^r e^{-i\omega_k t} \Delta\omega$$

$$w_n^r = \frac{\Gamma(N+1) \Gamma(N+r-n+1)}{\Gamma(N-n) \Gamma(N+r+1)}$$

Conclusions

- **The theory of dual integral equation has been reviewed**
- **The role of hypersingularity is examined**
- **The dual series representations are introduced**
- **The applications to seepage flow with sheet piles, crack problem and thin airfoil aerodynamics have been demonstrated.**
- **The applications of dual series representations to multi-support motions is demonstrated.**

Hypersingularity



Divergent series



Dual representation model

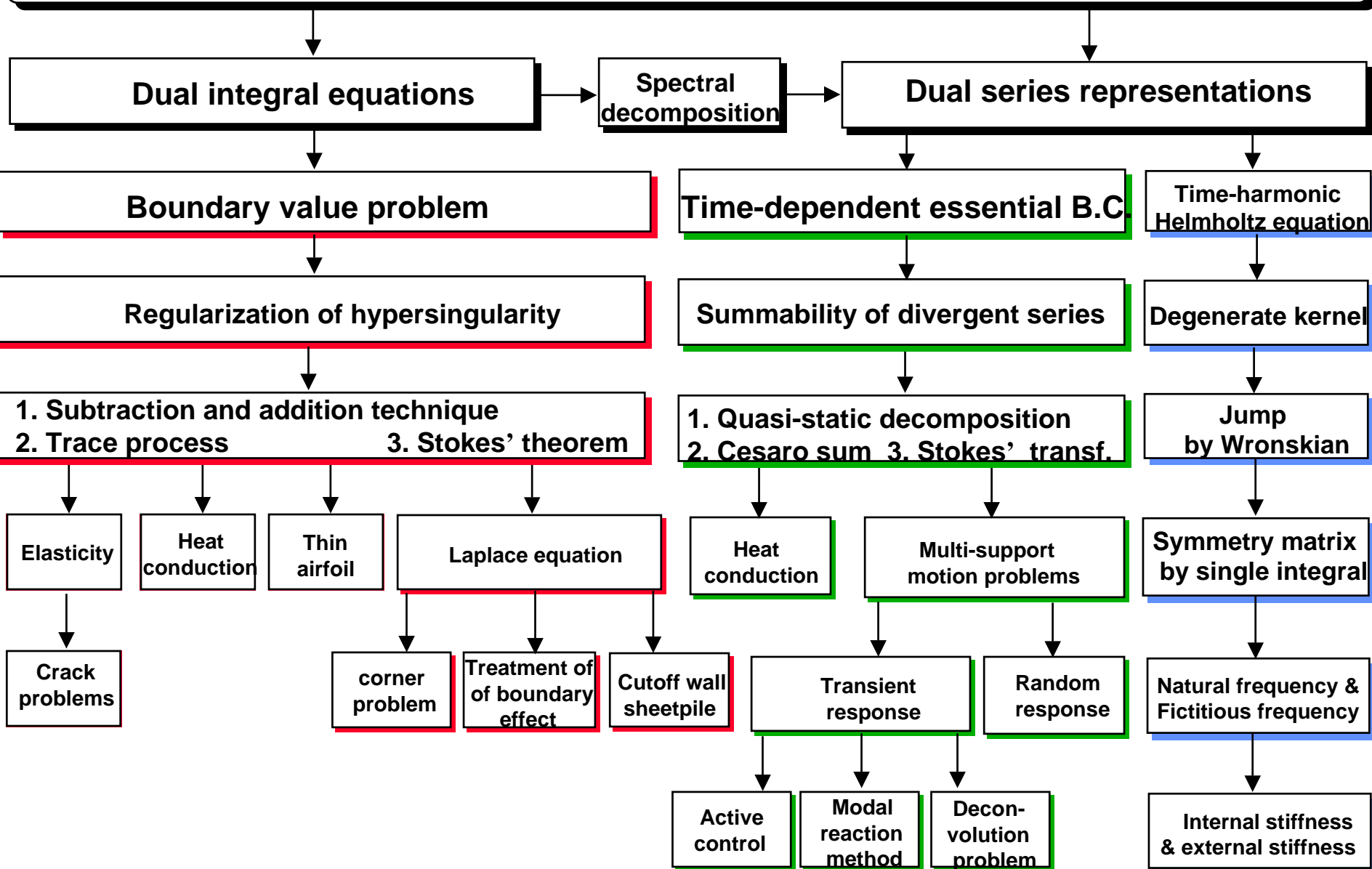

Why Dual Representation Model ?

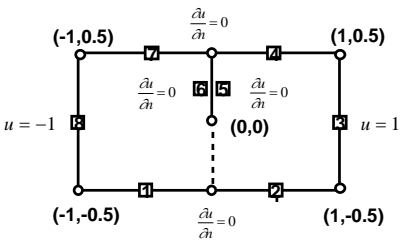
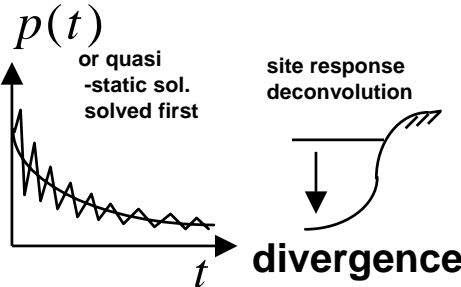
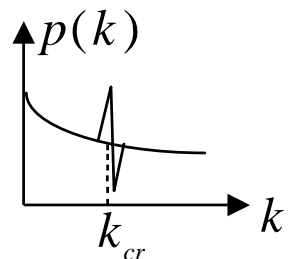
	Boundary value problem	Initial-boundary value problem	Time harmonic problem
Physical problem	Flow with corners or sheetpiles	Multi-support motions	exterior radiation
Mathematical tools	H.P.V. hypersingularity	Cesaro sum Stokes' transformation	Wronskian Hilbert transform determinant
Numerical problem			
Numerical improvement	avoid artificial boundary and. boundary effect	avoid quasi-static solution and accelerate convergence	Avoid fictitious eigenvalue

How to Simulate the Discontinuity ?

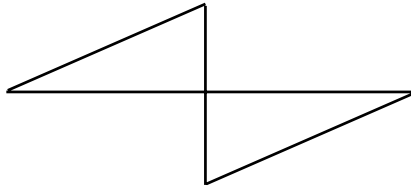

CPV + jump term

$$\pm \frac{1}{2} u(x) + CPV \int T(s, x) u(s) dB(s)$$

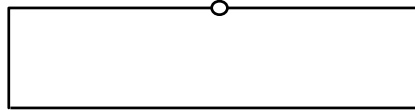

HPV

$$HPV \int M(s, x) u(s) dB(s)$$

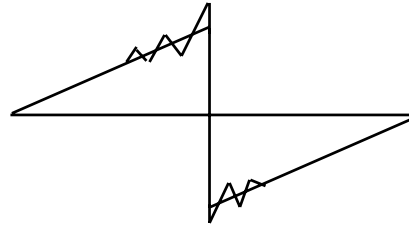

Gibbs phenomenon

$$\sum c_i u_i(x)$$

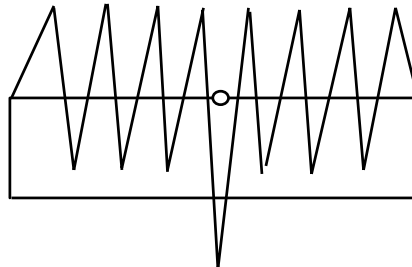

divergent series

$$\sum c_i t_i(x)$$

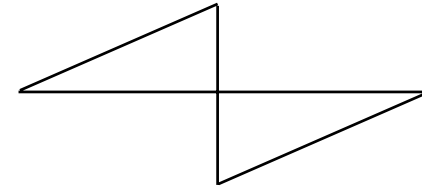

degenerate series

$$T^i(s, x) = \sum_{m=-\infty}^{m=\infty} \frac{i}{c_m} \{ \nabla_s C_m(ks) \cdot n(s) \} R_m(kx)$$

$$T^e(s, x) = \sum_{m=-\infty}^{m=\infty} \frac{i}{c_m} C_m(kx) \{ \nabla_s R_m(ks) \cdot n(s) \}$$

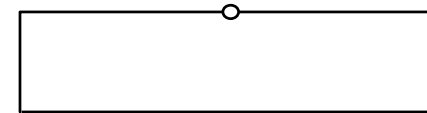

degenerate series

$$M^i(s, x) = \sum_{m=-\infty}^{m=\infty} \frac{i}{c_m} \{ \nabla_x C_m(ks) \cdot n(s) \} \{ \nabla_s R_m(kx) \cdot n(x) \}$$

$$M^e(s, x) = \sum_{m=-\infty}^{m=\infty} \frac{i}{c_m} \{ \nabla_x C_m(kx) \cdot n(x) \} \{ \nabla_s R_m(ks) \cdot n(s) \}$$